

OTC Hearing Aids

User Manual

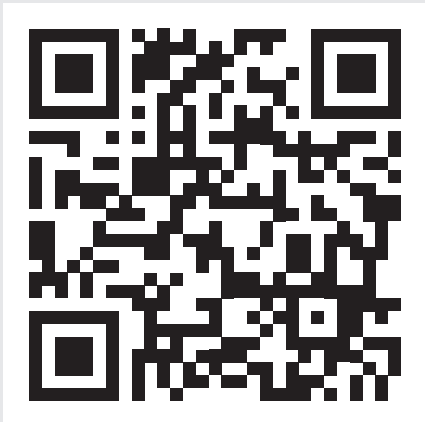

Want an easier setup?

Scan here

for quick step-by-step
video instructions

RCAHearingAidSupport.com

RSH052xx IB Version 01

Precautions and Warnings



WARNING: If you are younger than 18, do not use this. You should go to a doctor, preferably an ear-nose-throat (ENT) doctor, because your condition needs specialized care. Over-the-counter hearing aids are only for users who are age 18 and older.

This hearing aid is for adults with signs of mild to moderate hearing loss. How do you know if you have this?

- You have trouble hearing speech in noisy places
- You find it hard to follow speech in groups
- You have trouble hearing on the phone
- Listening makes you tired
- You need to turn up the volume on the TV or radio, and other people complain it's too loud

Some people with hearing loss may need help from a hearing healthcare professional. How do you know if you need to see one?

- You can't hear speech even if the room is quiet
- You don't hear loud sounds well, for example, you don't hear loud music, power tools, engines, or other very noisy things

If your hearing loss makes it hard to hear loud noises, this hearing aid may not be your best choice without help from a professional. If this hearing aid does not help you enough, ask for help from a hearing healthcare professional

This OTC hearing aid is for users age 18 and older. People who are younger than 18 with hearing loss should see a doctor, preferably an ENT, because they may need medical testing and management. Hearing loss can affect speech and learning, so professional fitting and continuing care are also important.

WARNING: When to See a Doctor

If you have any of the problems listed below, please see a doctor, preferably an ENT.

- Your ear has a birth defect or an unusual shape. Your ear was injured or deformed in an accident.
- You saw blood, pus, or fluid coming out of your ear in the past 6 months
- Your ear feels painful or uncomfortable
- You have a lot of ear wax, or you think something could be in your ear
- You get really dizzy or have a feeling of spinning or swaying (called vertigo)
- Your hearing changed suddenly in the past 6 months
- Your hearing changes: it gets worse then gets better again
- You have worse hearing in one ear
- You hear ringing or buzzing in only one ear

WARNING: This hearing aid should not cause pain when inserting it. Remove this device from your ear if it causes pain or discomfort when inserting or placing it. To try again, make sure to follow the instructions. If you feel pain or discomfort again, contact the manufacturer. You may also report this to the FDA as an adverse event according to the instructions that appear later.

WARNING: Your product contains a battery and charging system which is designed to work in temperatures that do not exceed 50°C (122°F). Leaving this product in a closed automobile or the trunk of an automobile where temperatures may exceed 50°C may result in permanent battery damage, fire, or explosion. Please remove your product from the automobile when you exit, do not place your product in the trunk of your automobile, and do not leave your product in any location where temperatures may exceed 50°C.

Caution: This is not hearing protection. You should remove this device if you experience overly loud sounds, either of short or long duration. You should use appropriate hearing protection in loud environments instead of wearing this device. As a general rule, if you would use ear plugs in a loud environment, you should remove this device and use ear plugs in that environment.

Caution: The sound output should not be uncomfortable or painful. You should turn down the volume or remove the device if the sound output is uncomfortably loud or painful. If you consistently need to turn the volume down, you may need to further adjust your device.

Caution: You might need medical help if a piece gets stuck in your ear. If any part of your hearing aid, like the eartip, gets stuck in your ear, and you can't easily remove it with your fingers, get medical help as soon as you can. You should not try to use tweezers or cotton swabs because they can push the part farther into your ear, injuring your eardrum or ear canal, possibly seriously.

Note: If you remain concerned, consult with a professional. If you try this device and continue to struggle with or remain concerned about your hearing, you should consult with a hearing healthcare professional.

Note: Expectations about what a hearing aid can do.

A hearing aid can benefit many people with hearing loss. However, you should know it will not restore normal hearing, and you may still have some difficulty hearing over noise. Further, a hearing aid will not prevent or improve a medical condition that causes hearing loss.

People who start using hearing aids sometimes need a few weeks to get used to them. Similarly, many people find that training or counseling can help them get more out of their devices.

If you have hearing loss in both ears, you might get more out of using hearing aids in both, especially in situations that make you tired from listening—for example, noisy environments.

Note: Tell the FDA about injuries, malfunctions, or other adverse events. To report a problem involving your hearing aid, you should submit information to the FDA as soon as possible after the problem. FDA calls them “adverse events,” and they might include: skin irritation in your ear, injury from the device (like cuts or scratches, or burns from an overheated battery), pieces of the device getting stuck in your ear, suddenly worsening hearing loss from using the device, etc.

Instructions for reporting are available at www.fda.gov/Safety/MedWatch, or call **1-800-FDA-1088**

This information and other labeling, including the user instructional brochure, are available on the internet at:
www.rcahearingaidsupport.com

You may also call 1-888-225-2644 to request a paper copy of this information and other labeling.

This manual is for model RSH052xx, where the xx means BG, GY, and BK.

Table of Contents

What's in the box?	7
Tour of the hearing aid	8
Getting started	10
1. Charge the hearing aids	10
2. Turn each hearing aid on.....	11
3. Adjust the volume	11
4. Put each hearing aid on	12
Welcome to a new world of sounds!	14
Tips for new users.....	15
Device information	19
Troubleshooting	20

What's in the box?

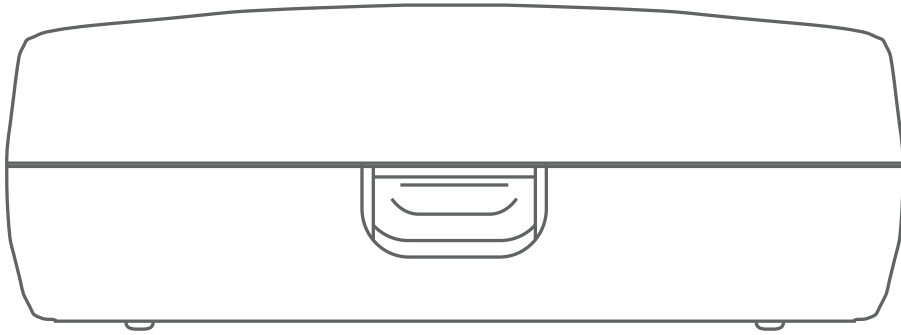

1 Carry Case

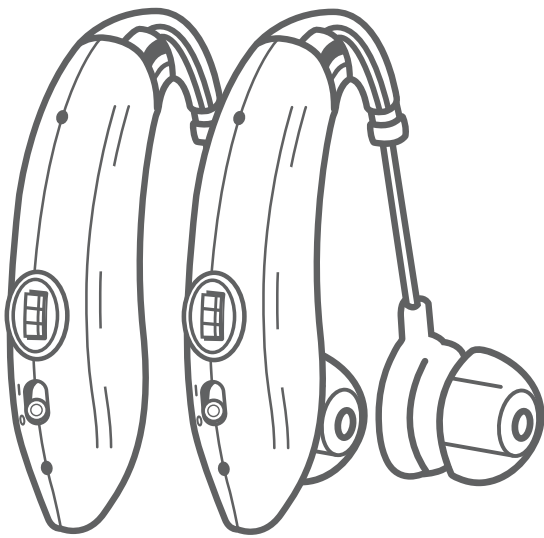

2 Hearing Aids with medium-sized domes attached

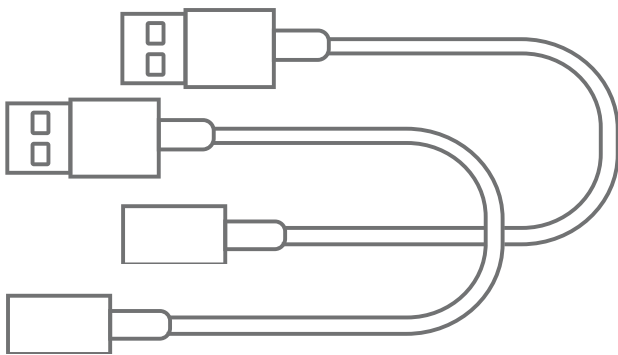

2 Charging Cables

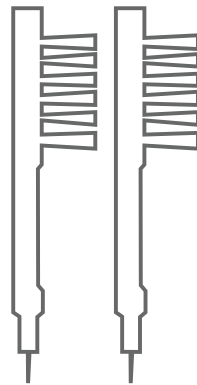

2 Cleaning Brushes/Picks



S x 2



M x 2



L x 2

Small, Medium, and Large Domes

Tour of the hearing aid

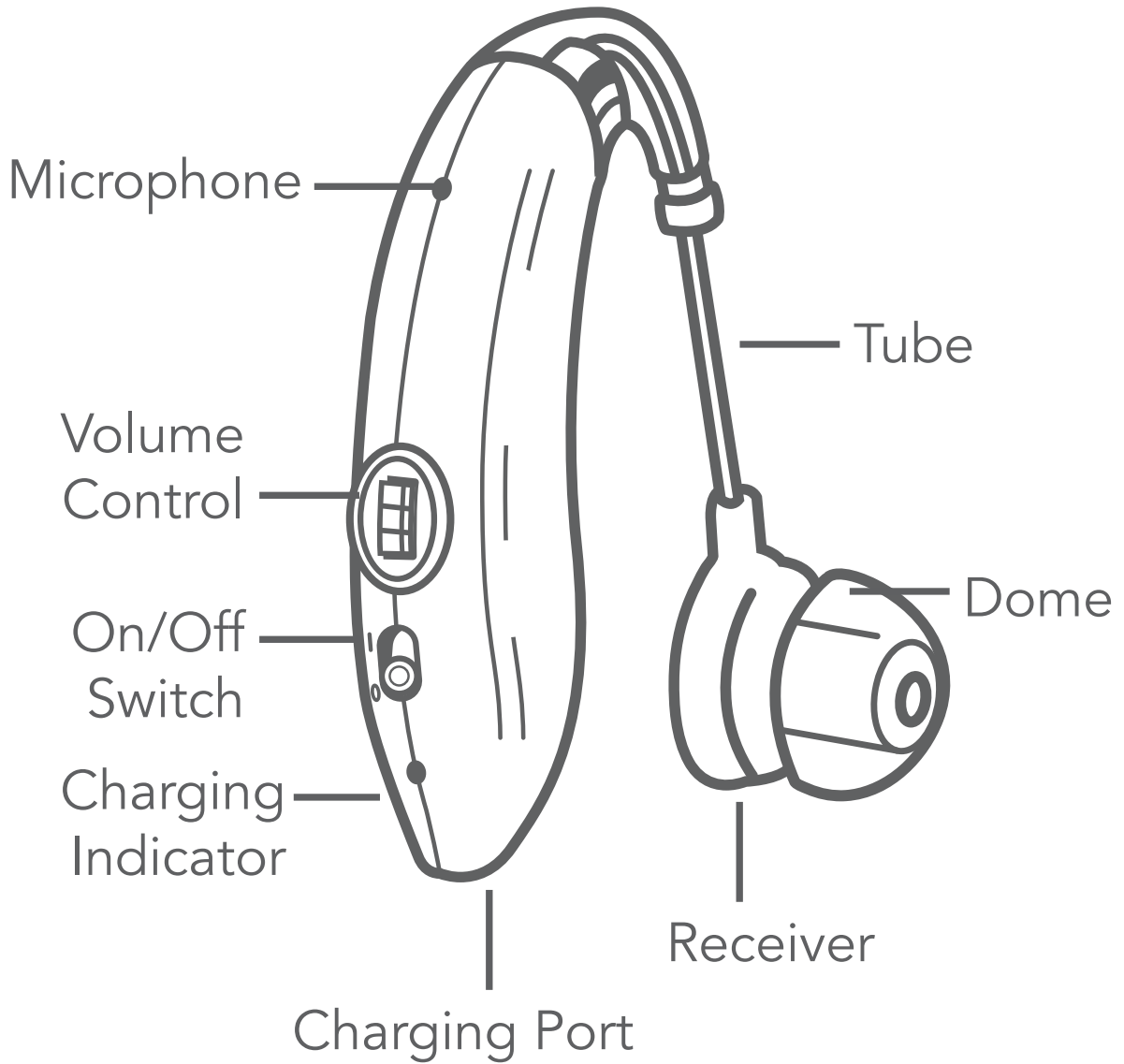

The **Microphone** picks up sound in your surroundings which the hearing aid processes and sends to your ear. You should try to keep this as unobstructed as possible.

The **Volume Control** wheel adjusts the amount of amplification applied to the sound. Rotate it up to increase the volume.

The **On/Off Switch** turns the hearing aid on (up position) and off (down position).

The **Charging Indicator** illuminates orange while the hearing aid is charging. It turns off when the hearing aid is completely charged.

The **Charging Port** connects to the provided charging cable to charge the hearing aid via a USB power source (like a computer or adapter).

The **Tube** carries the signal from the microphone to the receiver and dome. It can be rotated for use in the left or right ear.

The **Receiver** plays the processed sound into your ear.

The **Dome** fits in your ear snugly to carry the hearing aid's sound directly to your ear canal. Out of the box, the medium-sized dome is attached. Try one of the other sizes if this dome is too large or small for your ear.

Getting started

1. Charge the hearing aids

For best performance, charge the hearing aids completely before you use them for the first time.

Note: Make sure the hearing aids are turned off (switch in the down position) before you charge them.

Insert one end of the included charging cables in the charging ports on the bottom of each hearing aid. Insert the other ends into a USB power source (like a computer or USB power adapter).

Each hearing aid's charging indicator illuminates orange while the hearing aid is charging. It turns off when the hearing aid is fully charged.

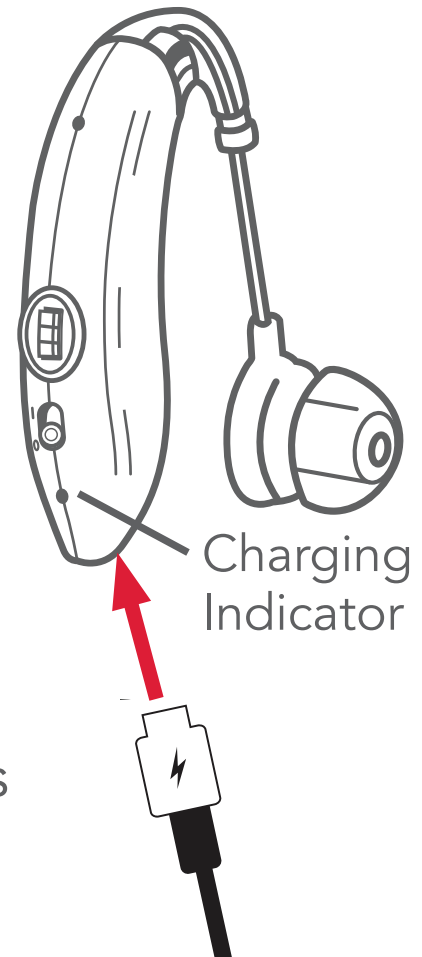

2. Turn each hearing aid on

Put the switch on the back of each hearing aid in the **I** (up) position to turn the it on.

3. Adjust the volume

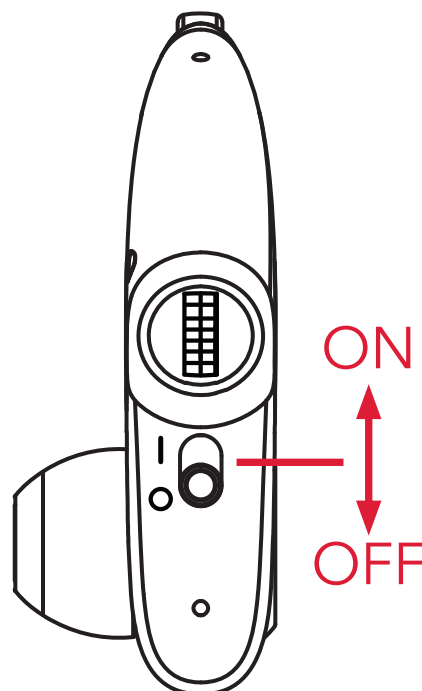

Set the volume wheel to its minimum setting before you put the hearing aid on for the first time.

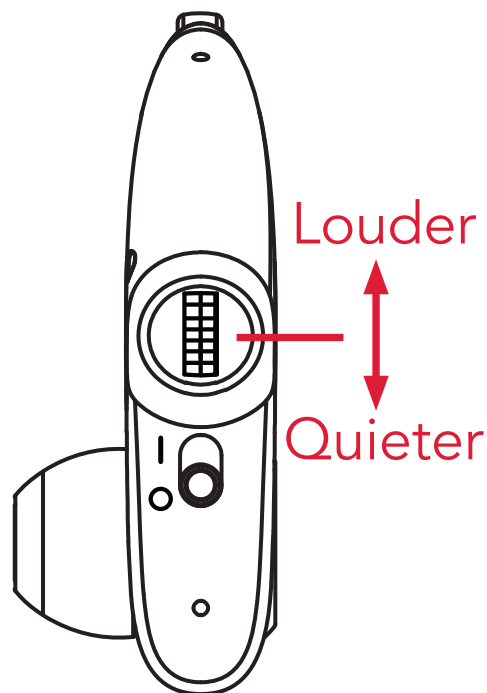

4. Put each hearing aid on

Out of the box, both hearing aids are configured for your right ear.

To use a hearing aid on your left ear: Rotate the receiver and dome so that the dome faces the opposite direction.

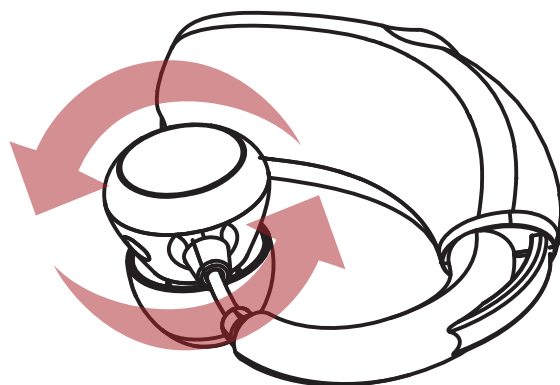

Trying on for the first time

Place each hearing aid body behind your ear. Then insert the dome gently in your ear so that it's securely in place.



Each hearing aid comes with a medium-sized dome installed. If this dome seems to large or small to fit your ear comfortably, change it for one of the other domes included.

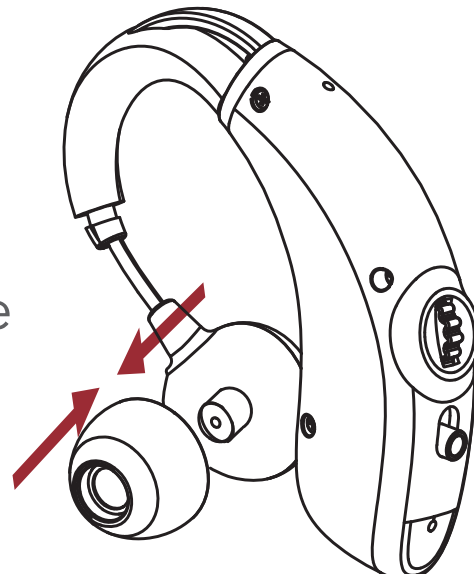

Adjusting the volume

Make sure each hearing aid is on—the on/off switch on the back of the hearing aid should be in the top position.

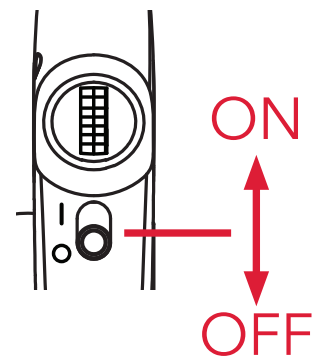

The volume wheel is directly above the on/off switch. Slowly increase the volume until you notice the volume of your surroundings increase.

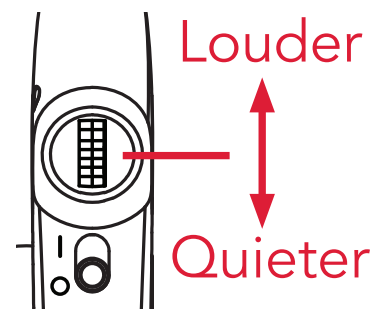

You'll need to experiment with different volume levels in different environments to see what's comfortable for you.

Welcome to a new world of sounds!

It might take a while to get used to! Your new RCA Hearing Aids let you experience sounds you might not have heard for a while: everyday sounds like clocks ticking, paper rustling or crinkling, nearby whispering or soft conversation, outdoor noises like wildlife or traffic, or nearby footsteps.

At first all these new sounds might be distracting, maybe even overwhelming.

Give yourself time to get accustomed—it could take as long as 30 days (or more). We recommend using your new hearing aids an hour or two a day at first, in quiet settings if possible. Then gradually increase the amount of time and variety of situations you use your new hearing aids in until they feel natural to you.

Tips for New Users

- Your own voice will sound strange at first when you're wearing your hearing aids. This is normal and normally goes away after a few weeks of use.
- Higher frequency sounds, like water running or paper crumpling, might seem loud at first. These higher frequencies are also essential to understanding speech clearly. Getting used to higher frequency sounds in your environment takes time and patience, but the trade-off is understanding speech more clearly. Most users find that after 3-4 weeks of regular use, the hearing aids make conversation easier, even in somewhat noisy environments.
- Using the phone might take some practice. Holding the phone close to your ear might cause feedback—a whistling or chirping from the hearing aid. If this happens, try tilting the phone or moving it away from your ear an inch or two.

continues on next page...

Tips for New Users (continued)

- Hearing conversations more clearly can be a game-changer for social gatherings and even one-on-one interactions. The following additional steps can take you even further:
 - Try to face the person you're talking or listening to
 - In noisy environments, try to position yourself so that the source of the noise is behind you
 - Don't shout! Just speak clearly and slowly.
 - In meetings or worship services without amplified sound, sit as close as you can to the sound source.
 - Ask your conversation partner to get your attention before speaking so that you can fully engage with them.

Cleaning & Care

Keeping your hearing aids clean is crucial to getting the most from them. Wearing a hearing aid can increase the amount of wax your ear produces, so it's especially important to perform the following cleaning routine daily.

- **Wipe the surface of the hearing aids** with a wet wipe, soft cloth, or tissue.
- **Brush around each hearing aid's microphone** using the provided brush.
- **Clean away any wax buildup in the domes and stems.**

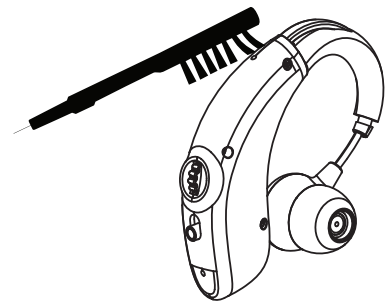

Remove the dome from each hearing aid's receiver. Use the provided pick to clean the inside of the stem. Clean the dome with a soft, moist cloth or mild soap and water. Make sure the dome is completely dry before you put it back on the receiver's stem.

With the proper care, your RCA hearing aids should provide years of use. It is important to keep the following cautions in mind.

- DO NOT get water on or in the hearing aids.
- DO NOT wear the hearing aids while swimming, showering, in heavy rain, or in a moist atmosphere (like a sauna).
- DO NOT use solvents or liquids on the hearing aid earpieces, tubes, or domes.
- DO NOT sleep with the hearing aids on.
- DO NOT leave the hearing aids in or near direct sunlight or excessive heat.
- Remove the hearing aids when applying cosmetics, perfume, aftershave, hairspray, lotion, or any other product that might get into the hearing aids.
- Remove the hearing aids during strenuous physical activities, like working out.
- Keep the hearing aids clean and dry.

Device information

Technical Data

Specification	Value
Max. OSPL 90	114 dBSPL
Full-on Gain	33dB
Total Harmonic Distortion	2%
Self-generated Noise	29dBA
Latency	8 ms
Frequency Range	F1 < 250 Hz and F2 > 5500 Hz
Expected Battery Life (from one full charge)	≥ 12 Hours
Expected Service Life	300 cycles
Max Charging Current	30mA

Troubleshooting

Problem: The hearing aid won't turn on.

Solution: Recharge the hearing aid. Plug the provided charging cable into the charging port on the bottom of the hearing aid. Plug the other end of the cable into a USB power source. The hearing aid's charging indicator illuminates. It turns off when the hearing aid is charged.

Problem: The hearing aid doesn't produce sound.

Solution: Make sure the hearing aid is charged and turned on (the power switch should be in the **I** [up] position). Then use the hearing aid's volume wheel to turn it up. If you still don't hear sound, clean the hearing aid's dome and microphone using the provided brush/pick.

Problem: The hearing aid whistles when I use it.

Solution: Make sure the dome is seated snugly in your ear. You might need to adjust it to get a better seal— it should fit snugly in your ear so that almost no sound escapes. If you can't get it to fit snugly, you might need to try a different dome size.

Problem: The hearing aid falls out of my ear.

Solution: Make sure you're using the right dome size for your ears. The dome should fit snugly in your ear and help secure the hearing aid in place.

Product Repair and Replacement

If your RCA hearing aids need to be replaced during their warranty period, please contact us at 1-888-225-2644 to arrange a return to the following address:

Voxx Return Center
180 Marcus Blvd.
Hauppauge, NY 11788



**WATER
RESISTANT**

Labeling and Date of Manufacture

The serial number is a 15-character code you can get by scanning the QR code on the hearing device with your phone. Each hearing device has its own unique serial number. The date of manufacture is encoded starting with the sixth character.

The sixth character shows the day of the week the product was manufactured.

1 = Sunday 2 = Monday
3 = Tuesday 4 = Wednesday
5 = Thursday 6 = Friday
7 = Saturday

The seventh and eighth characters are a code for the year of manufacture.

AA = 2022 AB = 2023
AC = 2024 AD = 2025

The ninth and tenth characters show the calendar week of the year.

12 = Calendar Week 12
13 = Calendar Week 13, etc.

Information and Description of Symbols



This symbol indicates important information on handling and product safety.



This is the symbol for caution and warning. This is a safety symbol used to highlight that there are specific warnings or precautions associated with the devices that are not otherwise found on the label.

Questions?

Visit
RCAHearingAidSupport.com
for FAQs, setup videos,
and more.